

A Power Quality analyser and fault recorder

Model PQI-DA smart

- ▶ Wall-mounted housing
- ▶ DIN-Rail housing
- ▶ Panel mounting housing



1. Application

Solving all measurement tasks in electrical grids can be a daunting task. The new Power Quality Interface and Disturbance Recorder *PQI-DA smart*, aimed at low, medium and high voltage grids, represents the A-Eberle response to such needs. This central component can be used either as Power Quality-Interface in accordance with all Power Quality standards or as a device for all physically defined/measured values in typical three-phase systems.

Beside the possibility of standard evaluations, the *PQI-DA smart* also has a high speed fault recorder capability with a 40.96kHz/10.24kHz recording rate and a half cycle r.m.s. registration, which allows for a detailed analysis of grid disturbances.

In particular, *PQI-DA smart* is suitable for monitoring, registering, evaluating and recording special reference quantities or quality agreements between the supplier of energy and the end customer. In addition, the device can provide many measured values in parallel for SCADA applications via standardized interfaces such as Modbus and PQDIF over IEC61850.

Modern voltage quality measuring instruments operate according to the IEC 62586 standard, which describes the complete product characteristic of a Power Quality Analyser. This standard defines not only the purpose of use, the EMC environment, the environmental conditions, but also the exact measurement methods (IEC 61000-4-30) in order to create a comparable basis for the user.

According to IEC 62586, the *PQI-DA smart* is a device PQI-A-FI-H and has therefore been fully certified in external laboratories.

Power Quality Interface – Class A – Fixed Installed Measurement Device for Indoor operation in Harsh EMC environments.

The *PQI-DA smart* meets all demands of the IEC 61000-4-30:2015 Ed 3 +A1:2021) standard for an A-Class device:

Parameter IEC61000-4-30	Class
Power frequency	A
Magnitude of the Supply Voltage	A
Flicker	A
Supply voltage dips and swells	A
Voltage interruptions	A
Supply voltage unbalance	A
Voltage harmonics	A
Voltage interharmonics	A
Mains signalling voltage	A
Underdeviation and overdeviation	A
Measurement aggregation intervals	A
Time-clock uncertainty	A
Flagging	A
Transient influence quantities	A

The measuring device and the development are subject to strict security requirements within the scope of the requirements in the area of KRITIS. In relation to these, an active patch management, encrypted communication standards as well as a User Rights Management (URM) via RADIUS are available in the device! This also includes signed firmware updates, security logging and active protection against brute force attacks. All this contributes to a secure operation in your IT environment!

2. Design

The *PQI-DA smart* has been developed for measurements performed within public grids as well as for recording PQ data within an industrial environment up to 690V (L-L) measurement voltage. Its key characteristics, making it suitable for such environments, are:

- No moving parts (fans, hard drives etc.)
- CAT IV
- Extensive storage capability (can be extended up to 32 GB by the user, permitting several years recording without connection to database)
- ▶ **Optional "IEC61000-4-7 - 2kHz to 9kHz" (B1)**
 - Frequency band measurement of voltage and current according IEC 61000-4-7 from 2 kHz to 9 kHz.
 - Sampling rate of voltage and current inputs 40.96 kHz
- ▶ **Optional: "PQDIF data format" (F1)**
 - Open data exchange format according to IEEE1159-3 via MMS / IEC61850 (feature P2)

2.1 Characteristics of the Power-Quality Interface *PQI-DA smart*

2.1.1 Technical Data

- 1.7-inch colour display
- Keypad for basic/direct device configuration
- 1 GB internal memory
- Input channel bandwidth 20 kHz
- 4 voltage inputs
FSR : 480V L-N, Accuracy < 0.1%
- 4 current inputs
- 1A/5A nominal, 500A max current for 1 sec.
- 1V voltage input for current clamps
- Simultaneous processing of sampled and calculated voltages and currents
- Oscilloscopic voltage and current recorder
sampling rate : 40.96kHz / 10.24kHz
- Half cycle recorder :
power frequency, r.m.s. of voltages and currents, voltage and current phasors, power
recording rate : ~10ms(50Hz) / ~8.33ms (60Hz)
- Powerful recorder triggering
- Online streaming of voltages and currents at 40.96 kHz sampling rate.
- IEC 61000-4-30, Class A voltage quality processing
- Recording of DIN EN 50160 power quality events

- Spectral analysis 2 kHz...9 kHz,(35 frequency bands, BW = 200Hz) of voltages and currents according (IEC 61000-4-7)
- Phase of voltage and current harmonics n=2..50
- 2 general purpose digital inputs (Trigger, Recording Start / Stop, General documentation of level)
- 2 relay outputs for protection monitoring and alarm
- EDGE function - 32 freely configurable monitoring states for monitoring and triggering all measured variables - Output as binary message or via protocol
- Complex analysis software WinPQ lite (sold as a package)
- **As an option:** Analysis of the data on an MYSQL-based database using the WinPQ software package. Permanent communication and evaluation of the data with many devices in parallel.

Communication Protocols

- MODBUS RTU
- MODBUS TCP

- IEC60870-5-104 (Option P1)
- IEC61850 (Option P2)

Time synchronisation protocols (Receive / Slave)

- IEEE1344 / IRIG-B000..007
- GPS (NMEA +PPS)
- DCF77
- NTP

Interfaces

Ethernet	RJ45 (10/100 Mbit)
2 * RS232/RS485 on terminals	switchable

Dimensions

L x B x H	160 x 90 x 58 mm
-----------	------------------

Weight

Weight	502g
--------	------

Voltage inputs			Voltage inputs		
Feature	E1	E2	Feature	E1	E2
Channels	U ₁ , U ₂ , U ₃ , U _{N/E/4}				@ 10%..100%U _{nom}
Electrical safety DIN EN 61010	150V CAT II	300V CAT IV 600V CAT III	Dip duration		±20 ms @ 10 %..100 % U _{nom}
Input reference level	PE	PE	Swell residual voltage		±0.2% U _n @ 100 %..150 % U _{nom}
Impedance -> PE	2 MΩ 25pF	10 MΩ 25pF	Swell duration		±20 ms @ 100 %..150 % U _{nom}
Nominal input voltage U _{nom}	100V _{AC} /√3	230 V _{AC}	Interruption duration		±20 ms @ 1 %..100 % U _{nom}
Full scale range (FSR)	0...120 V _{AC} L-E	0...480 V _{AC} L-E	Voltage unbalance		±0.15 % @ 1 %..5 % reading
Overload, per- manent	150V _{AC}	600V _{AC}	Mains signalling voltage (< 3 kHz)		±5 % of reading @ U _s = 3 %..15 % U _n ±0.15 % U _{nom} @ U _s = 1 %..3 % U _n
Maximum crest factor @ U _n	3				
Bandwidth	DC...20 kHz				
Nominal power frequency f _n	50 Hz / 60 Hz				
Frequency range of the fundamental	f _n ± 15 % 42.5..50..57.5 Hz 51.0..60..69.0 Hz				

Accuracy		
Fundamental, r.m.s. U ₁ ≤ 150% U _{nom} 0°C ≤ TA ≤ +45°C: -25°C ≤ TA ≤ +55°C:		±0.1% v. U _{nom} ±0.2% v. U _{nom}
Fundamental, Phase U ₁ ≥ 10% U _{nom} :		±0.02°
Harmonics n = 2...50, r.m.s. U _h ≥ 1% U _{nom} : U _h < 1% U _{nom} :		±5.0% v. U _h ±0.05% v. U _{nom}
Harmonics n = 2...50, Phase U _h ≥ 1% U _{nom} :		±0.5°
Interharmonics n = 1...49, r.m.s. U _{ih} ≥ 1% U _{nom} : U _{ih} < 1% U _{nom} :		±5.0% v. U _h ±0.05% v. U _{nom}
Power frequency		±1mHz @ 10%...200%U _{nom}
Flicker DIN EN 61000-4-15:2011		Class F2
Dip residual voltage		±0.2 % U _{nom}

Current inputs		
Option	C30	C31
Channels	I1, I2, I3, I _{N/4}	
Electrical safety DIN EN 61010	300V CAT III	
Input type	potentialfrei	
Impedance	≤ 4mΩ	
Nominal input cur- rent I _n	5 A _{AC}	
Full scale range (FSR)	10A _{AC}	100A _{AC}
Overload capacity permanent ≤ 10s ≤ 1s	20 A _{AC} 100 A _{AC} 500 A _{AC}	
Waveform	AC, any	
Maximum crest fac- tor @ I _n	3	30
Bandwidth	25Hz...20kHz	
Tightening torque	2 Nm	

Accuracy		
Feature	30	C31
Fundamental, r.m.s.	$I_1 \geq 10\%$ FSR: $\pm 0.1\%$ v. I_1 $I_1 < 10\%$ FSR: $\pm 0.01\%$ v. FSR	$I_1 = 1\% \dots 20\%$ FSR: $\pm 0.5\%$ v. I_1 $I_1 < 1\%$ FSR: $\pm 0.005\%$ v. FSR
Fundamental, Phase	$I_1 \geq 10\%$ FSR: $\pm 0.1^\circ$	$I_1 = 1\% \dots 20\%$ FSR: $\pm 0.5^\circ$
Harmonic $n = 2 \dots 50$, r.m.s. $I_h \geq 3\% I_{nom}$: $I_h < 3\% I_{nom}$:	$\pm 5.0\%$ v. I_h $\pm 0.15\%$ v. I_{nom}	$\pm 10\%$ v. I_h $\pm 0.3\%$ v. I_{nom}

Harmonic $n = 2 \dots 50$, Phase $I_h \geq 3\% I_{nom}$:	$\pm 0.5^\circ$	$\pm 2.0^\circ$
Interharmonic $n = 1 \dots 49$, r.m.s. $I_{ih} \geq 3\% I_{nom}$: $I_{ih} < 3\% I_{nom}$:	$\pm 5.0\%$ v. I_{ih} $\pm 0.15\%$ v. I_{nom}	$\pm 10\%$ v. I_{ih} $\pm 0.3\%$ v. I_{nom}

Feature	C40	C44	C45
Full Scale Range (FSR)	0.35V _{AC} @ 50Hz	0.50V _{AC}	$\pm 5.6V$
Impedance	1M Ω	1M Ω	1M Ω
Input type	symmetrisch		
Isolation	basic (SELV)	basic (SELV)	basic (SELV)
External sensors	Rogowski coil, potential free	current clamp, potential free	Hall-Sensor, potential free
Differential overload, permanent	10V _{AC}	$\pm 15V$	$\pm 15V$
Common mode area	$\pm 15V$	$\pm 15V$	$\pm 15V$
Bandwidth	25Hz...20kHz	DC...20kHz	DC...20kHz

Accuracy			
Grundschiwingung, r.m.s. $I_1 \geq 10\%$ FSR: $I_1 < 10\%$ FSR:	$\pm 0.2\%$ v. I_1 $\pm 0.02\%$ v. FSR	$\pm 0.1\%$ v. I_1 $\pm 0.01\%$ v. FSR	$\pm 0.1\%$ v. I_1 $\pm 0.01\%$ v. FSR
Grundschiwingung, Phase $I_1 \geq 10\%$ FSR:	$\pm 0.2^\circ$	$\pm 0.1^\circ$	$\pm 0.1^\circ$
Harmonische $n = 2 \dots 50$, r.m.s. $I_h \geq 1\%$ FSR: $I_h < 1\%$ FSR:	$\pm 5.0\%$ v. I_h $\pm 0.05\%$ v. FSR	$\pm 5.0\%$ v. I_h $\pm 0.05\%$ v. FSR	$\pm 5.0\%$ v. I_h $\pm 0.05\%$ v. FSR
Harmonische $n = 2 \dots 50$, Phase $I_h \geq 1\%$ FSR:	$\pm 1.0^\circ$	$\pm 0.5^\circ$	$\pm 0.5^\circ$
Zwischenharmonische $n = 1 \dots 49$, r.m.s. $I_{ih} \geq 1\%$ FSR: $I_{ih} < 1\%$ FSR:	$\pm 5.0\%$ v. I_{ih} $\pm 0.05\%$ v. FSR	$\pm 5.0\%$ v. I_{ih} $\pm 0.05\%$ v. FSR	$\pm 5.0\%$ v. I_{ih} $\pm 0.05\%$ v. FSR

Storage of measured values	
Internal memory	1024 MB
SD memory card	1 GByte to 32 GByte

Binary inputs (BI)		
Feature	M1	M2
2 binary inputs	0 V...250 V _{AC}	0 V...48 V _{DC}
Range	/V _{DC}	
<ul style="list-style-type: none"> — H – Level — L – Level 	<ul style="list-style-type: none"> > 35 V < 20 V 	<ul style="list-style-type: none"> > 10V < 5V
Signal frequency	DC ... 70 Hz	DC ... 70 Hz
Input resistance	> 100 kΩ	6.8 kΩ
Electrical isolation	Optocoupler, electrically isolated	
Electrical safety DIN EN 61010	300V	

Binary outputs (BO)	
2 binary outputs	1 x closer 1 x changeover
Contact specification (EN60947-4-1, -5-1) : Configuration: Nominal voltage Nominal current Nominal load AC1 Nominal load AC15, 230VAC Interrupting power DC1, 30/110/220 V	1 x SPST (Single Pole Single Throw) 1 x SPDT (Single Pole Double Throw) 250VAC 6 A 1500 VA 300 VA 6/0.2/0.12 A
Number of switching operations AC1	≥ 60·10 ³ electrical
Electrical isolation:	Isolated from all internal potentials
Electrical safety DIN EN 61010	300V

Power Supply		
Feature	H1	H2
AC Nominal range [V]	100...240	-
AC Operating range [V]	90...264	-
DC Nominal range [V]	110...320	24...60
DC Operating range [V]	100...350	18...75
Power consumption	≤ 10 W < 20 VA	≤ 10 W
Frequency Nominal	50...60Hz	DC
Frequency Operating	40...70Hz	DC
External fuse characteristics	6A B	6A B
Energy storage	2 sec	2 sec

Environmental parameters	Storage and transport	Operation
Ambient temperature : Limit range of operation	IEC 60721-3-1 / 1K5 -40 ... +70°C IEC 60721-3-2 / 2K4 -40 ... +70°C	IEC 60721-3-3 / 3K6 -25 ... +55°C
Ambient temperature : Rated range of operation H1 Rated range of operation H2	---	IEC DIN EN 61010 -25 ... +45°C -25 ... +50°C
Relative humidity: 24h average No condensation or ice	5...95 %	5...95 %
Solar radiations	---	700W/m2
Vibration, earth tremors	IEC 60721-3-1 / 1M1 IEC 60721-3-2 / 2M1	IEC 60721-3-3 / 3M1

Electrical safety

- IEC 61010-1
- IEC 61010-2-030

Protection class	1
Pollution degree	2
Overvoltage category mains supply option : H1 H2	300V / CAT III 150V / CAT III
Measurement category	300V / CAT IV 600V / CAT III
Altitude	≤ 2000m
Protection class	IP 20

Electromagnetic Compatibility

Immunity

- IEC 61000-6-5, environment H

Emissions

- CISPR22 (EN 55022) , class A

2.1.2 Mechanical design

The PQI-DA smart is mountable on the wall or via its DIN rail housing.

All connections are accessible via Phoenix type terminals. The connections are made by using plug-in/clamping technology, except for the current and voltage inputs.

For the TCP/IP interface one RJ 45-connector is available.

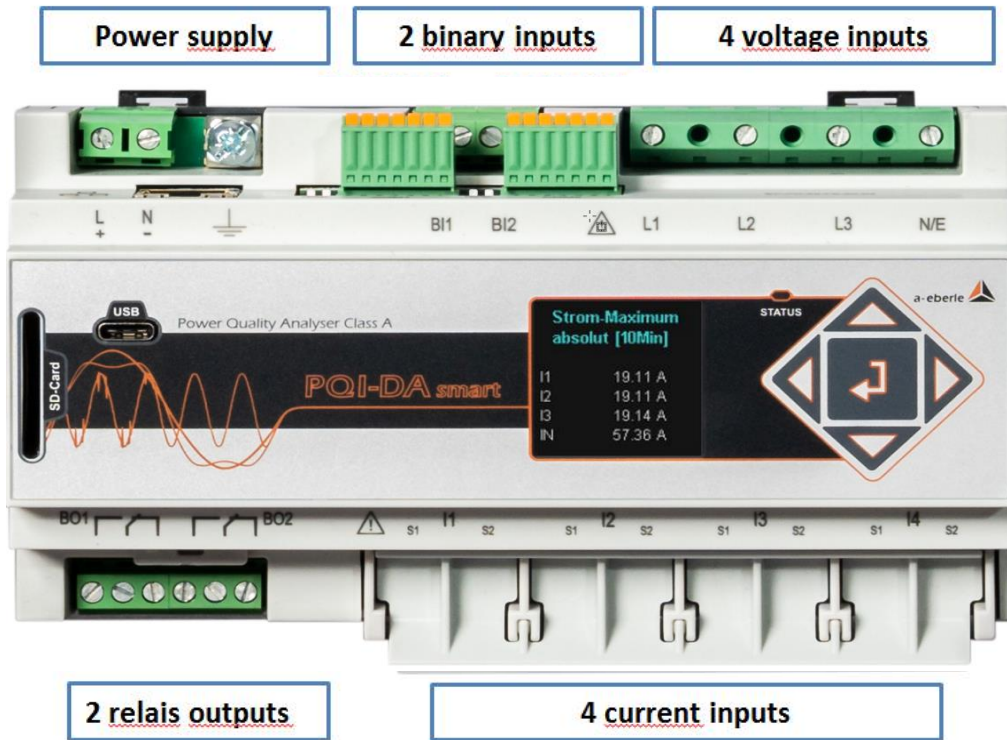

Front view PQI-DA smart

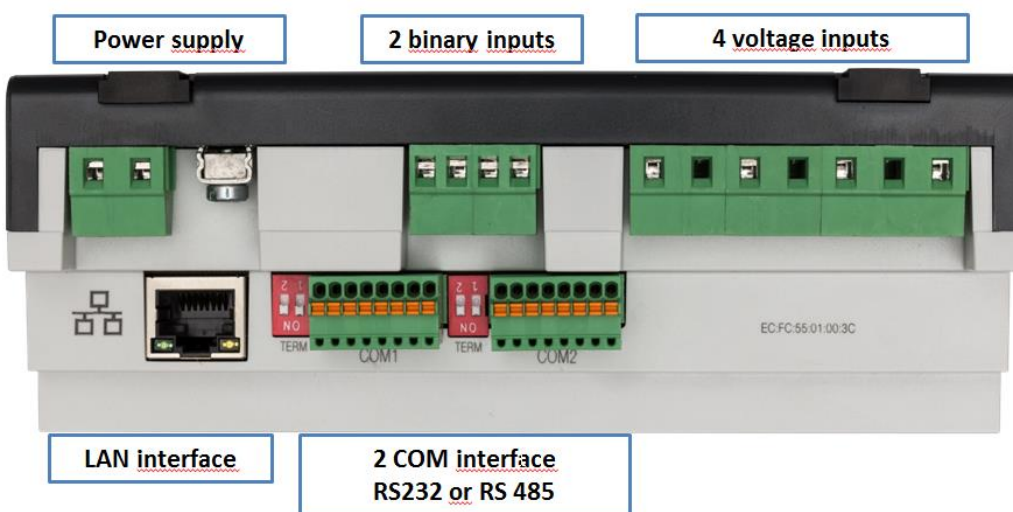

Side view of PQI-DA smart

2.1.3 Terminal strip number PQI-DA smart

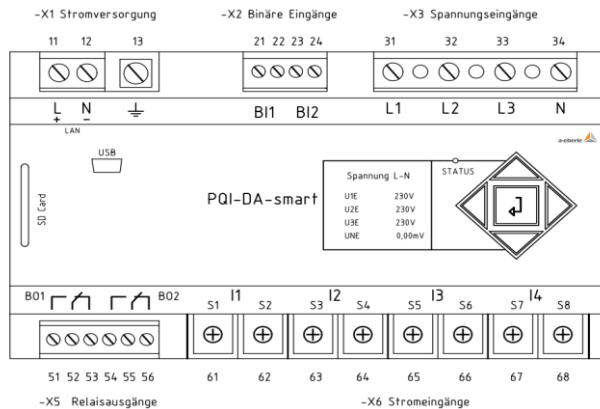

Terminal strip no.	Designation		Function	Terminal no.
X1	Auxiliary voltage	U _H	L (+)	11
			L (-)	12
X1	Ground	GND	E	13
X2	Binary input (M1/M2)	BI1	+	21
			-	22
		BI2	+	23
			-	24
X3	Phase voltage	U ₁	L1	31
	Phase voltage	U ₂	L2	32
	Phase voltage	U ₃	L3	33
	Neutral point voltage	U ₄	N	34
X5	Binary output 1	R1	NC contact	51
			Pol	52
			NO contact	53
	Binary output 2	R2	NC contact	54
			Pol	55
			NO contact	56
X6	Phase current L1	I1	S1 (K)	61
	S2 (I)		62	
	Phase current L2	I2	S1 (K)	63
	S2 (I)		64	
Phase current L3	I3	S1 (K)	65	
		S2 (I)	66	
Neutral conductor / sum current	I4	S1 (K)	67	
		S2 (I)	68	

2.1.4 Dimensions

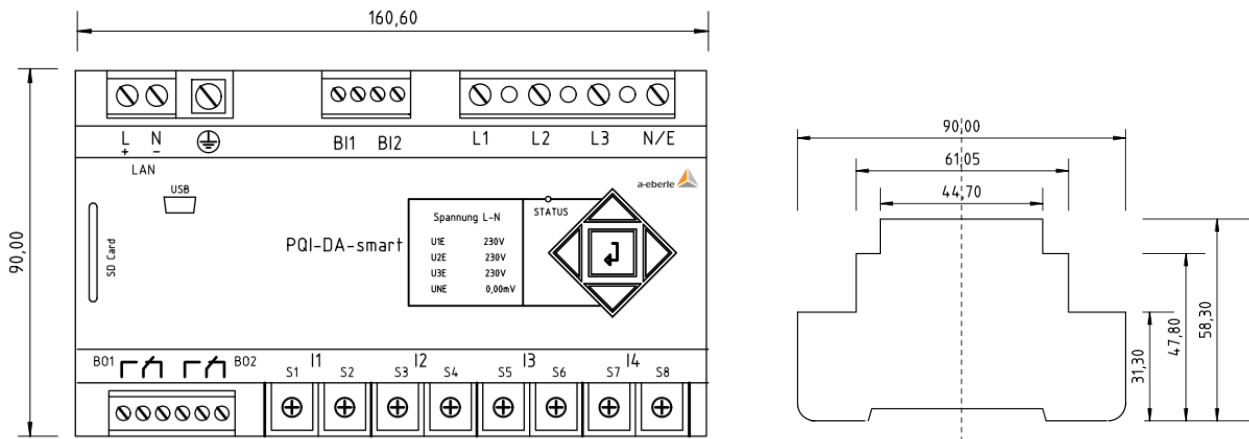

2.1.5 Colour display

The device's 1.7-inch colour display provides information about the correct connections for the measuring cables and current transducers, as well as it indicates online data on voltage, current, THD, power values and energy.

The number of PQ-events that occurred, the oscilloscope records and R.M.S. records for different periods (last day, week or month) are also displayed.

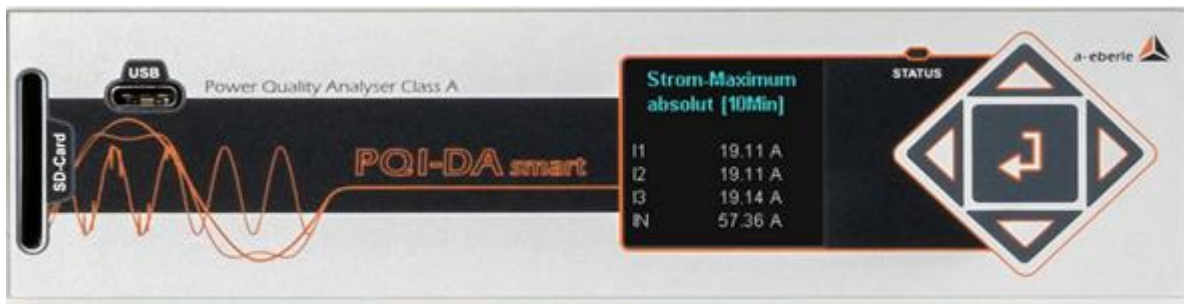

2.2 Measurement / Functions

PQI-DA smart complies with the automatic event detection and measurement standards, which are:

EN50160:2021/ IEC61000-2-2 / IEC61000-2-12 /IEC61000-2-4 (Class 1; 2; 3) / NRS048 / IEEE519 / IEC61000-4-30 Class A Ed 3/ IEC 61000-4-7 / IEC61000-4-15 / IEEE1159-3

Continuous Recording:

Five fixed and two variable measurement time intervals are available for continuous recording:

10/12 T (200ms), 1 sec, n*sec, 150/180 T (3sec), n*min, 10 min, 2 h

Time Interval Voltage	10/ 12T	150/ 180T	10 min	2 h	1 s	10s	N* s	N* min
PQDIF			✓	✓		✓		
Power frequency	✓	✓	✓	✓	✓	✓	✓	✓
Extremes, standard deviation of power frequency (10s)			✓			✓		
r.m.s. values (IEC61000-4-30)	✓	✓	✓	✓	✓		✓	✓
Extremes, standard deviation of T/2-values			✓					
Underdeviation [%] , Overdeviation [%] (IEC61000-4-30)	✓	✓	✓	✓				
Harmonic subgroups n= 0..50 (IEC61000-4-7)	✓	✓	✓	✓				
Maximum values of 10/12 T harmonic subgroups n = 2..50			✓					
Interharmonic subgroups n=0..49 (IEC61000-4-7)	✓	✓	✓	✓				
Total Harmonic Distortion (THDS) (IEC61000-4-7)	✓	✓	✓	✓	✓		✓	✓
Partial Weighted Harmonic Distortion (PWHD)	✓	✓	✓	✓	✓		✓	✓
Unbalance, negative-/positive- sequence , sequence sign	✓	✓	✓	✓	✓		✓	✓
Unbalance, zero-/positive- sequence	✓	✓	✓	✓	✓		✓	✓
Positive-, negative-, zero sequence phasors	✓	✓	✓	✓	✓		✓	✓
Phasors (fundamental)	✓	✓	✓	✓	✓		✓	✓
Flicker (IEC61000-4-15)			✓	✓				
Instant flicker (IEC61000-4-15)	✓		✓					
Mains signalling voltages [%] (IEC61000-4-30)	✓	✓						
Phase angle(zero crossings) of phase voltage harmonics n=2..50 to fundamental of reference voltage	✓	✓	✓	✓				
Frequency bands 1..35 , 2kHz..9kHz, r.m.s. (IEC61000-4-7)			✓	✓	✓		✓	✓

Time Interval Current	10/ 12T	150 /180T	10 min	2 h	1 s	N* s	N* min
PQDIF			✓	✓			
r.m.s. values	✓	✓	✓	✓	✓	✓	✓
Extremes of T/2-values			✓				
Harmonic subgroups n= 0..50 (IEC61000-4-7)	✓	✓	✓	✓			
Maximum values of 10/12 T harmonic subgroups n = 2..50			✓				
Interharmonic subgroups n=0..49 (IEC61000-4-7)	✓	✓	✓	✓			
Total Harmonic Distortion (THDS) (IEC61000-4-7)	✓	✓	✓	✓	✓	✓	✓
Total Harmonic Currents	✓	✓	✓	✓	✓	✓	✓
Partial Weighted Harmonic Distortion (PWHD)	✓	✓	✓	✓	✓	✓	✓
Partial Odd Harmonic Currents (PHC)	✓	✓	✓	✓	✓	✓	✓
K-Factors	✓	✓	✓	✓	✓	✓	✓
Unbalance, negative-/positive- sequence , sequence sign	✓	✓	✓	✓	✓	✓	✓
Unbalance, zero-/positive- sequence	✓	✓	✓	✓	✓	✓	✓
Positive-, negative-, zero sequence phasors	✓	✓	✓	✓	✓	✓	✓
Phasors (fundamental)	✓	✓	✓	✓	✓	✓	✓
Phase angle(zero crossings) of current harmonics n=2..50 to fundamental of reference voltage	✓	✓	✓	✓			
Frequency bands 1..35 , 2kHz..9kHz, r.m.s. (IEC61000-4-7)			✓	✓	✓	✓	✓

Time Interval Energy	10 min	2 h	1 s	N* s	N* min
PQDIF	✓	✓			
Active energy, phase	✓	✓	✓	✓	✓
Active energy, total	✓	✓	✓	✓	✓
Exported active energy, phase	✓	✓	✓	✓	✓
Exported active energy, total	✓	✓	✓	✓	✓
Imported active energy, phase	✓	✓	✓	✓	✓
Imported active energy, total	✓	✓	✓	✓	✓
Reactive energy (inductive), phase	✓	✓	✓	✓	✓
Reactive energy (inductive), total	✓	✓	✓	✓	✓
Exported reactive energy (inductive), phase	✓	✓	✓	✓	✓
Exported reactive energy (inductive), total	✓	✓	✓	✓	✓
Imported reactive energy (inductive), phase	✓	✓	✓	✓	✓
Imported reactive energy (inductive), total	✓	✓	✓	✓	✓
Total apparent energies, phase& total	✓	✓	✓	✓	✓
Export apparent energies, phase & total	✓	✓	✓	✓	✓
Import apparent energies, phase & total	✓	✓	✓	✓	✓
Distortion reactive energies, phase & total	✓	✓	✓	✓	✓

Time Interval Power	10 min	2 h	1 s	N* s	N* min
PQDIF	✓	✓			
Active power, phase	✓	✓	✓	✓	✓
Active power, total	✓	✓	✓	✓	✓
Active power extremes	✓				
Reactive power, phase	✓	✓	✓	✓	✓
Reactive power, total	✓	✓	✓	✓	✓
Reactive power extremes	✓				
Apparent power, phase	✓	✓	✓	✓	✓
Apparent power, total	✓	✓	✓	✓	✓
Fundamental active power, phase	✓	✓	✓	✓	✓
Fundamental active power, total	✓	✓	✓	✓	✓
Fundamental reactive power, phase	✓	✓	✓	✓	✓
Fundamental reactive power (displacement), total	✓	✓	✓	✓	✓
Fundamental apparent power, phase	✓	✓	✓	✓	✓
Phase angle of fundamental apparent power, phase	✓	✓	✓	✓	✓
Fundamental apparent power, total	✓	✓	✓	✓	✓
Phase angle of fundamental apparent power, total	✓	✓	✓	✓	✓
Reactive distortion power, phase	✓	✓	✓	✓	✓
Reactive distortion power, total	✓	✓	✓	✓	✓
Active power factors, phase, total	✓	✓	✓	✓	✓
Reactive power factors, phase, total	✓	✓	✓	✓	✓
COS ϕ + sign, phase, total	✓	✓	✓	✓	✓
SIN ϕ + sign, phase, total	✓	✓	✓	✓	✓
COS ϕ + sign of reactive distortion power, phase, total	✓	✓	✓	✓	✓
Capacitive-, inductive scaling factor of COS ϕ (-1..0..+1) :	✓	✓	✓	✓	✓
tan ϕ (L+), Phase, total on imported inductive reactive energy	✓		✓	✓	✓
tan ϕ (C-),Phase, total on exported capacitive reactive energy	✓		✓	✓	✓
tan ϕ (L-),Phase, total on exported inductive reactive energy	✓		✓	✓	✓
tan ϕ (C+),Phase, total on imported capacitive reactive energy	✓		✓	✓	✓
Triggered interval mean active power, phase					
Triggered interval mean active power, total					
Triggered interval mean reactive power, phase					
Triggered interval mean reactive power, total					

2.3 Oscilloscopic recorder

Sampling rate: 40.96 kHz or 10.24 kHz
 Max. Record length: 4s (40.96 kHz) or 16s (10.24 kHz)

Quantities	
3-wire system	4-wire system
phase – ground voltages	phase –neutral voltages
residual voltage	neutral – ground voltage
phase – phase voltages	
phase currents	
total current	neutral current

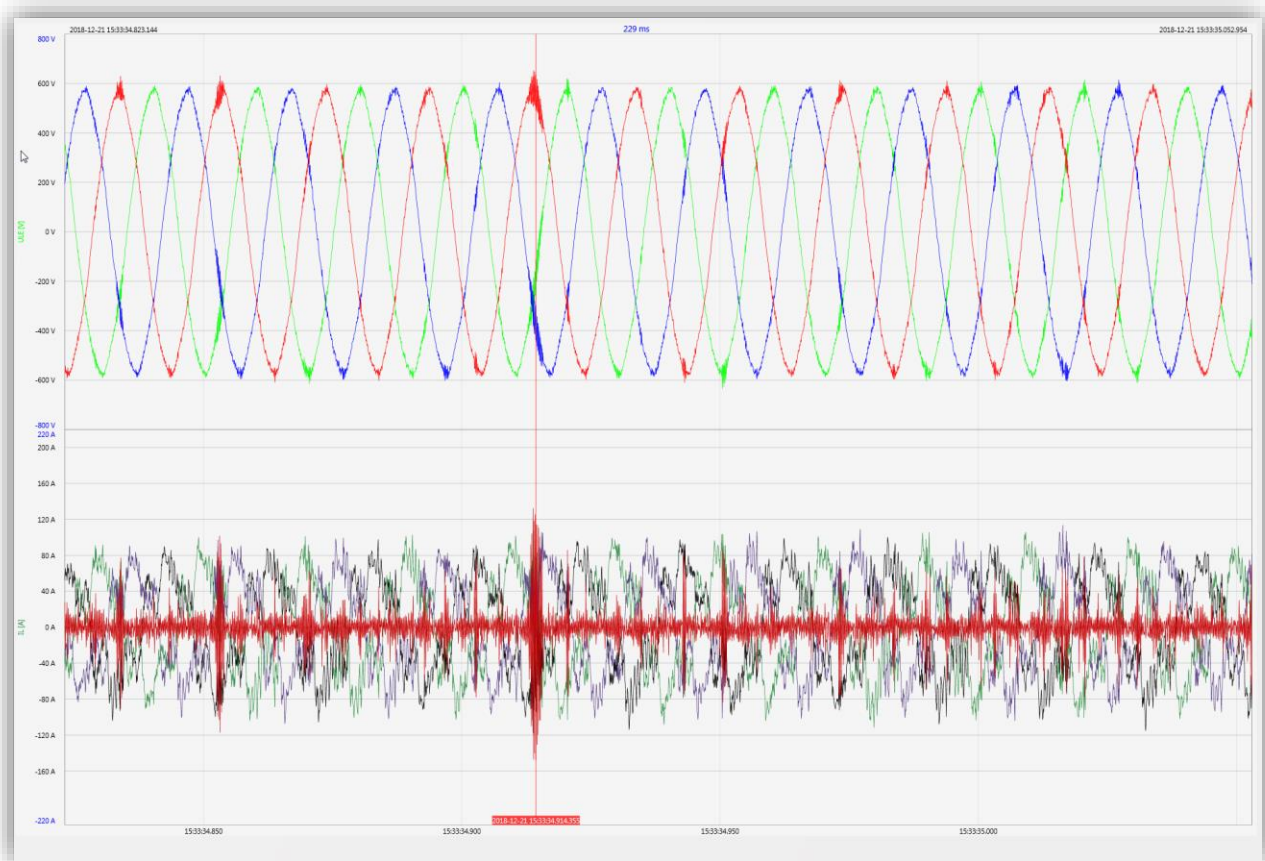

2.4 Half cycle recorder

Recording rate: ~10ms (50Hz) or ~8.333ms (60Hz)

Max. Record length: 6min (50Hz) or 5min (60Hz)

Quantities	
Power frequency	
r.m.s. voltages	
r.m.s. currents	
Active power, phase	
Reactive power, phase	
Active power, total	
Fundamental reactive power (displacement), total	
Phase angle of fundamental apparent power, total	
Voltage phasors (fundamental)	
Current phasors (fundamental)	
Positive-, negative-, zero sequence voltage phasors	
Positive-, negative-, zero sequence current phasors	

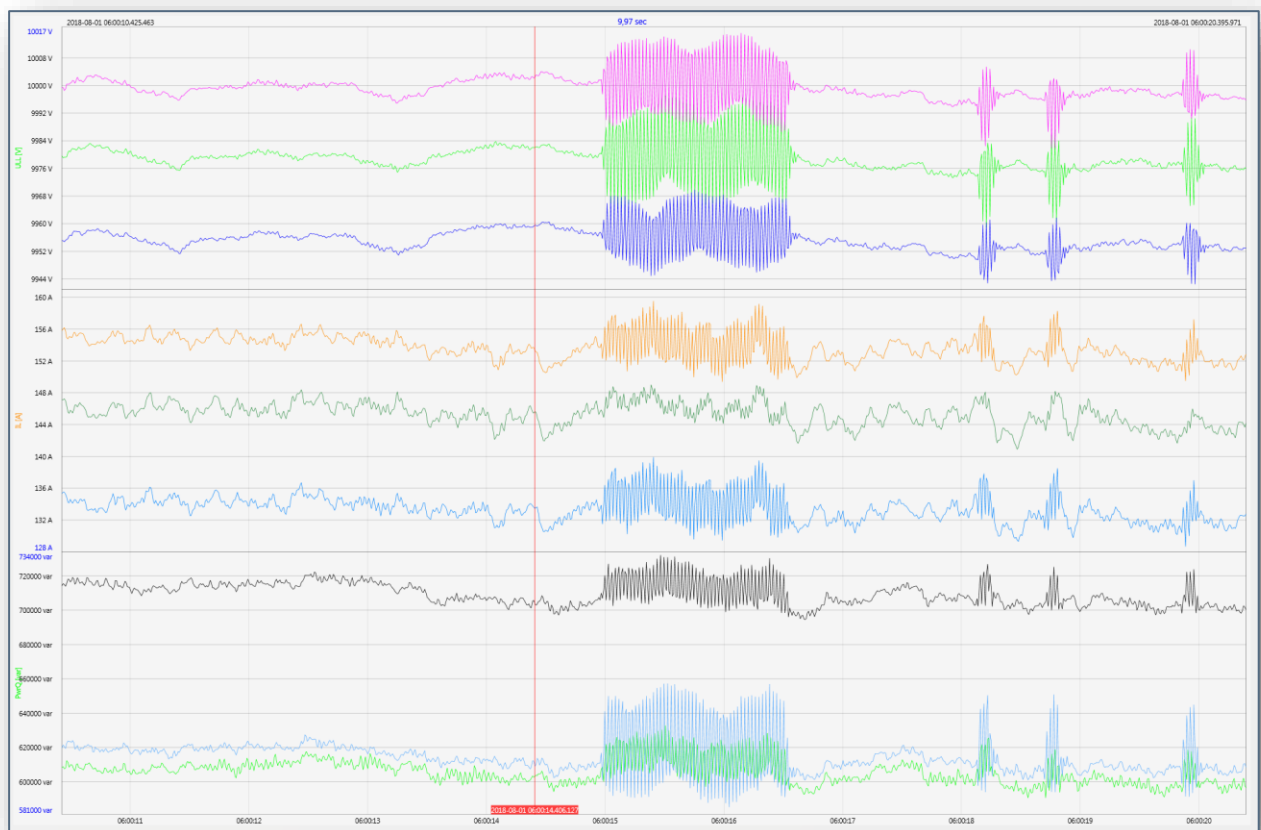

2.5 Recorder triggering

trigger quantity	lower	upper	step
r.m.s. phase voltages (T/2)	✓	✓	✓
r.m.s. phase-phase voltages (T/2)	✓	✓	✓
r.m.s. residual/neutral-ground voltage (T/2)		✓	✓
Positive sequence voltage (T/2)	✓	✓	
Negative sequence voltage (T/2)		✓	
Zero sequence voltage (T/2)		✓	
Phase voltage phase (T/2)			✓
phase voltages wave shapes (wave shape filter)	+/- threshold		
phase-phase voltages wave shapes (wave shape filter)			
residual/neutral-ground voltage wave shape (wave shape filter)			
r.m.s. phase currents (T/2)	✓	✓	✓
r.m.s. total / neutral current (T/2)		✓	✓
Power frequency (T/2)	✓	✓	✓
Binary inputs (debounced)	rising, falling slope		
Command	external		

2.6 PQ Events:

trigger quantity	lower	upper
voltage dip (T/2)	✓	
voltage swell (T/2)		✓
voltage interruption (T/2)	✓	
voltage rapid voltage change (T/2)	sliding average filter mean +/- threshold	
voltage change (10min)	✓	✓
voltage unbalance (10min)		✓
mains signalling voltage (150/180T)		✓
voltage harmonics (10min)		✓
voltage THD (10min)		✓
voltage short term flicker PST (10min)		✓
voltage long term flicker PLT (10min)		✓
power frequency (10s)	✓	✓

2.7 Online mode for direct readings

Measurement / Functions

Oscilloscopic recorder

Voltage and current harmonics $n=2..50$

Voltage and current interharmonics $n=0..49$

Voltage and current harmonics 2-9kHz

Frequency spectra up to 20 kHz of voltages and currents

Online streaming of all data classes and all measured values

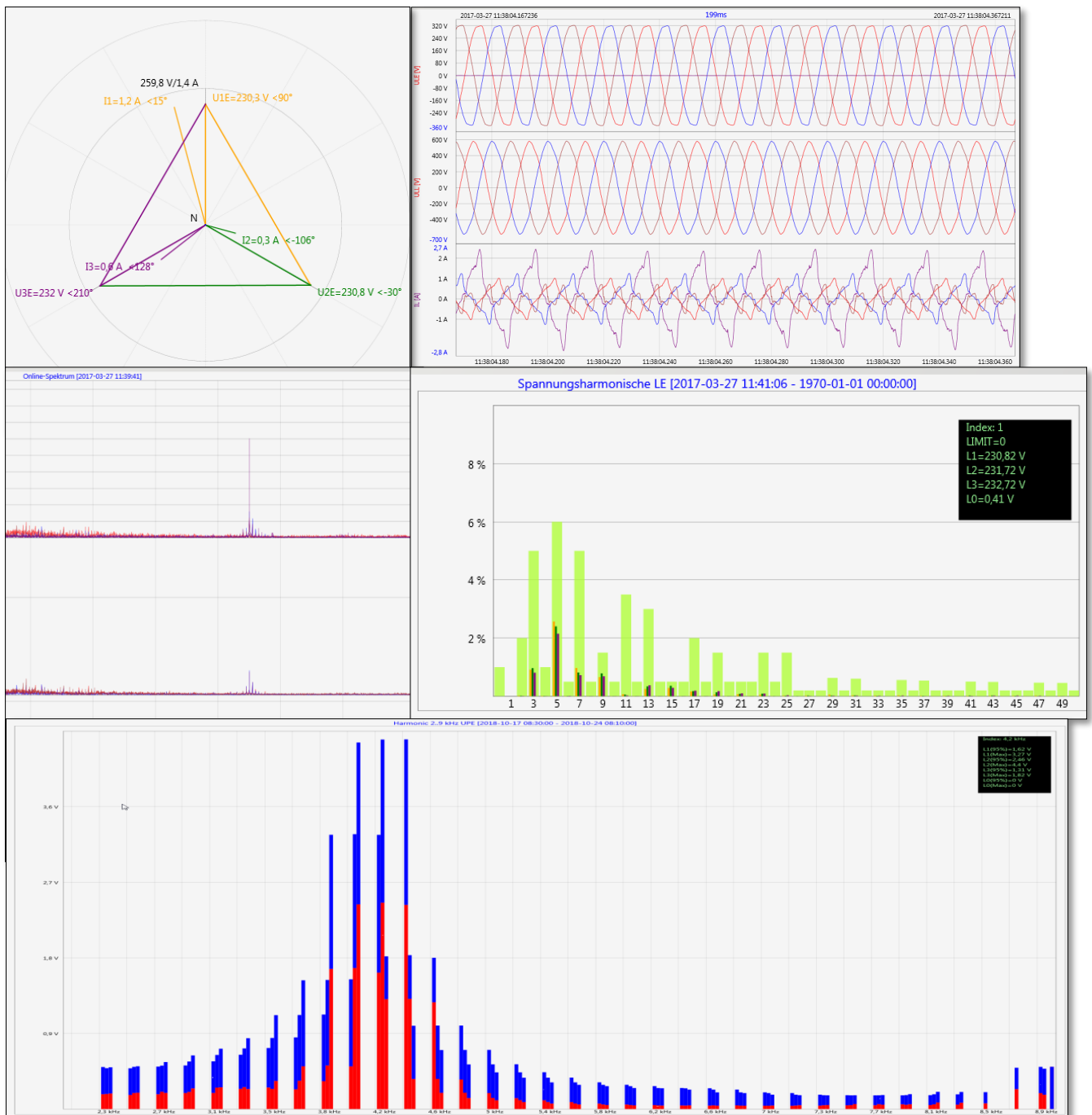

3. Order specifications *PQI-DA smart*

For determining the smart code ordering details:

- Only one unit can be ordered for codes with the same capital letter.
- When a code's capital letter is followed by the number 9, additional information in plain text is required.
- When a code's capital letter is followed only by zeros, the code may be omitted.

Characteristic	Code
Power Quality Interface and fault recorder <ul style="list-style-type: none"> ● 4 voltage converters, 4 current transformers ● In accordance with DIN EN-50160 and IEC 61000-4-30 (Class A) ● 2 digital inputs ● 2 relay outputs ● WinPQ lite software for <i>PQI-DA smart</i> 	<i>PQI-DA smart</i>
Supply voltage <ul style="list-style-type: none"> ● AC 90 V..110 V..264 V or DC 100 V..220 V..350 V ● DC 18 V...60 V...70 V 	H1 H2
Rated value of the input voltage <ul style="list-style-type: none"> ● 100V 2MΩ (CAT IV 300V) ● 100V / 400V / 690V 10MΩ (CAT IV 300V) 	E1 E2
Current inputs <ul style="list-style-type: none"> ● 4 current inputs for metering circuit 1A/5A (range 10A) ● 4 current inputs for protection circuit 1A/5A (range 100A) ● 4 current inputs for Rogowski Coils ● 4 AC current inputs for current clamps (0,5 V_{AC}) ● 4 DC current inputs for current clamps (5,6 V_{DC}) 	C30 C31 C40 C44 C45
Binary inputs <ul style="list-style-type: none"> ● 2 programmable binary inputs (AC/DC 48..250V) ● 2 programmable binary inputs (DC 10..48V) 	M1 M2
Option IEC61000-4-7 (40,96kHz sampling) <ul style="list-style-type: none"> ● 10,24kHz sampling; without 2kHz to 9kHz measurement ● Frequency measurement of voltage and current from 2 kHz to 9 kHz 40.96kHz sampling oscilloscope recorder	B0 B1
Option communication protocol <ul style="list-style-type: none"> ● Modbus RTU & TCP ● IEC 60870-5-104 (RJ45) ● IEC61850 (RJ45) 	P0 P1 P2
Option Data format <ul style="list-style-type: none"> ● Without PQDIF export function according to IEEE1159-3 ● With PQDIF export function according to IEEE1159-3 Data transfer via feature P2 - IEC61850 / MMS	F0 F1
<ul style="list-style-type: none"> ● German ● English ● French ● Spanish ● Italian ● Chinese 	G1 G2 G3 G4 G5 G6

3.1 Option PQI-DA smart

Software WinPQ lite	Code
Software WinPQ lite For parameterization, as well as reading measurement data and online data as a single-user licence – free of charge	
Expansion WinPQ lite For recalibration of the PQI-DA smart and test report creation	900.9287
WinPQ database	Code
Software WinPQ For parameterization, archiving and evaluation of PQI-D, PQI-DA, PQI-DA smart and PQI-DE measurement data with the following basic functions: <ul style="list-style-type: none"> ● 32-bit/64-bit Windows program interface ● Database for saving the measured values per measuring point ● Data access via TCP/IP network ● Visualization option for all measured variables retrievable from a PQI-D, PQI-DA, PQI-DA smart and PQI-DE as a function of time and as a statistical variable ● Automatic reporting according to EN50160; IEC61000-2-2 / 2-4; IEEE519; etc. ● Automatic export functions (Comtrade, PQDif, ASCII, PDF) and fault report transmission ● One additional workstation license for one Windows user is included in the price 	WinPQ
Licences <ul style="list-style-type: none"> ● as single-user license for 2 PQ measuring instruments (PQI-D, PQI-DA, PQI-DA smart, PQI-DE) ● as single-user license for 2 to 10 PQ measuring instruments (PQI-D, PQI-DA, PQI-DA smart, PQI-DE) ● as single-user license for > 10 PQ measuring instruments (PQI-D, PQI-DA, PQI-DA smart, PQI-DE) ● as single-user license for > 100 PQ measuring instruments (PQI-D, PQI-DA, PQI-DA smart, PQI-DE) 	L0 L1 L2 L3
Operating instructions <ul style="list-style-type: none"> ● German ● English 	A1 A2

PQI-DA smart	Code
SD-memory card (external): 4 GByte industrial standard	900.9099.04
Frame for panel mounting DIN-rail, wall mounted housing	564.0435 564.0433
Radio time clock interface DFC 77	111.9024.01
GPS-Clock – Navilog Set - RS485 . DIN-Rail GPS receiver, GPS converter 5m connection cable, mounting bracket	111.7083
Power supply for Navilog (DIN rail power supply, 88-264VAC/24V, 10W)	111.7079
Rogowski Coil for C40; 1...3000A; 85mV/1000A; 10Hz..20kHz; 15m connection cable; one piece	111.7087
Current clamp for C44 high accurate for secondary measurement circuits 0...5A; 100mV/A; 10Hz...10kHz; 10m connection cable; one piece	111.7095

A. Eberle GmbH & Co. KG

Frankenstraße 160
D-90461 Nuremberg

Tel.: +49 (0) 911 / 62 81 08-0
Fax: +49-(0)911-62 81 08 99
E-mail: info@a-eberle.de

<http://www.a-eberle.de>

Presented by:

Copyright 2022 by A. Eberle GmbH & Co. KG
Subject to change without prior notice.

Version: 07/18/2022 3:40 PM